

1700V 300A IGBT Half Bridge Module

1700V 300A IGBT 半桥模块

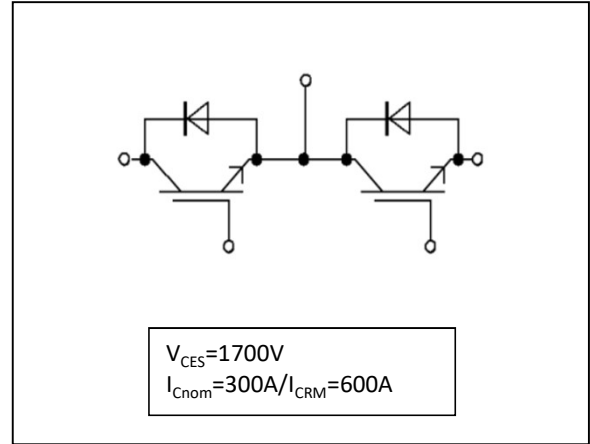

Features:

- 1700V Trench+ Field Stop technology
- Freewheeling diodes with fast and soft reverse recovery
- $V_{CE(sat)}$ with positive temperature coefficient
- Low switching losses

Typical Applications:

- Motor/Servo Drives
- High Power Converters
- UPS
- Photovoltaic

产品特性:

- 1700V沟槽栅+场截止技术
- 快速的软恢复特性续流二极管
- 导通压降具有正温度系数
- 低开关损耗

典型应用:

- 电机/伺服驱动器
- 大功率变流器
- 不间断电源
- 光伏发电

Package / 封装

Item	Symbol	Conditions	Values	Unit
绝缘测试电压 Isolation test voltage	V_{ISOL}	RMS, f = 50 Hz, t =1 min	4.0	kV
模块基板材料 Material of module baseplate			Cu	
内部绝缘 Internal isolation		基本绝缘 (class 1, IEC 61140) Basic insulation (class 1, IEC 61140)	Al_2O_3	
爬电距离 Creepage distance	d_{Creep}	端子-散热片/terminal to heatsink	29.0	mm
	d_{Creep}	端子-端子/terminal to terminal	23.0	
电气间隙 Clearance	d_{Clear}	端子-散热片/terminal to heatsink	23.0	mm
	d_{Clear}	端子-端子/terminal to terminal	11.0	
相对电痕指数 Comparative tracking index	CTI		>400	

Item	Symbol	Conditions	Values			Unit
			Min.	Typ.	Max.	
杂散电感, 模块 Stray inductance module	L_{SCE}			20		nH
模块引线电阻,端子-芯片 Module lead resistance, terminals - chip	$R_{CC'+EE'}$	$T_C=25^{\circ}C$		0.70		m Ω
储存温度 Storage temperature	T_{stg}		-40		125	$^{\circ}C$
模块安装的安装扭矩 Mounting torque for module mounting	M6		3.0		6.0	Nm
端子联接扭矩 Terminal connection torque	M6		2.5		5.0	Nm
重量 Weight	G			320		g

IGBT

Maximum Rated Values / 最大额定值

Item	Symbol	Conditions	Values	Unit
集电极-发射极电压 Collector-emitter Voltage	V_{CES}	$T_{vj}=25^{\circ}C$	1700	V
栅极-发射极电压 Maximum gate-emitter voltage	V_{GES}		± 20	V
瞬态栅极-发射极电压 Transient gate-emitter voltage	V_{GES}	$t_p \leq 10\mu s, D=0.01$	± 30	V
连续集电极直流电流 Continuous DC collector current	I_C	$T_C=25^{\circ}C$	500	A
		$T_C=100^{\circ}C$	300	
最大脉冲集电极电流 Pulsed collector current, t_p limited by T_{jmax}	I_{Cpulse}		600	A
功率损耗 Power dissipation	P_{tot}		1500	W

Characteristic Values / 特征值

Item	Symbol	Conditions	Values			Unit	
			Min.	Typ.	Max.		
集电极-发射极饱和电压 Collector-emitter saturation voltage	$V_{CE(sat)}$	$I_C=300A, V_{GE}=15V$	$T_{vj}=25^{\circ}C$		1.70	2.00	V
			$T_{vj}=125^{\circ}C$		1.95		
			$T_{vj}=150^{\circ}C$		2.00		
栅极阈值电压 Gate threshold voltage	$V_{GE(th)}$	$V_{CE}=V_{GE}, I_C=12mA$		5.1	5.9	6.6	V
集电极-发射极截止电流 Collector-emitter cut-off current	I_{CES}	$V_{CE}=1700V, V_{GE}=0V$	$T_{vj}=25^{\circ}C$			100	μA
			$T_{vj}=150^{\circ}C$			5	mA
栅极-发射极漏电流 Gate-emitter leakage current	I_{GES}	$V_{CE}=0V, V_{GE}=\pm 20V, T_{vj}=25^{\circ}C$		-200		200	nA
栅极电荷 Gate Charge	Q_G	$V_{CE}=900V, I_C=300A, V_{GE}=\pm 15V$			1.6		μC
输入电容 Input Capacitance	C_{ies}	$V_{CE}=25V, V_{GE}=0V, f=100kHz$			25.0		nF
输出电容 Output Capacitance	C_{oes}				1.4		
反向传输电容 Reverse Transfer Capacitance	C_{res}				0.4		
内部栅极电阻 Internal gate resistor	R_{Gint}	$T_{vj}=25^{\circ}C$			3.5		Ω
开通延迟时间 (电感负载) Turn-on delay time, inductive load	$t_{d(on)}$	$V_{CC}=900V, I_C=300A$ $R_G=3.3\Omega,$ $V_{GE}=\pm 15V$	$T_{vj}=25^{\circ}C$		185		ns
			$T_{vj}=125^{\circ}C$		220		ns
			$T_{vj}=150^{\circ}C$		230		ns
上升时间 (电感负载) Rise Time, inductive load	t_r		$T_{vj}=25^{\circ}C$		76		ns
			$T_{vj}=125^{\circ}C$		92		ns
			$T_{vj}=150^{\circ}C$		96		ns
关断延迟时间 (电感负载) Turn-off delay time, inductive load	$t_{d(off)}$	$V_{CC}=900V, I_C=300A$ $R_G=3.3\Omega,$ $V_{GE}=\pm 15V$	$T_{vj}=25^{\circ}C$		550		ns
			$T_{vj}=125^{\circ}C$		665		ns
			$T_{vj}=150^{\circ}C$		695		ns
下降时间 (电感负载) Fall time, inductive load	t_f		$T_{vj}=25^{\circ}C$		390		ns
			$T_{vj}=125^{\circ}C$		610		ns
			$T_{vj}=150^{\circ}C$		675		ns
开通损耗能量 (每脉冲) Turn-on energy loss per pulse	E_{on}	$V_{CC}=900V, I_C=300A$ $R_G=3.3\Omega,$ $V_{GE}=\pm 15V$	$T_{vj}=25^{\circ}C$		44.7		mJ
			$T_{vj}=125^{\circ}C$		73.2		mJ
			$T_{vj}=150^{\circ}C$		84.6		mJ
关断损耗能量 (每脉冲) Turn off Energy loss per pulse	E_{off}		$T_{vj}=25^{\circ}C$		68.5		mJ
			$T_{vj}=125^{\circ}C$		94.7		mJ
			$T_{vj}=150^{\circ}C$		102.9		mJ
短路数据 SC data	I_{SC}	$V_{GE} \leq 15V,$ $V_{CC}=900V$	$tp \leq 10\mu s$ $T_{vj}=150^{\circ}C$			950	A
IGBT结-外壳热阻 IGBT thermal resistance, junction-case	R_{thJC}					0.10	K/W
工作温度 Operating Temperature	T_{Jop}			-40		175	$^{\circ}C$

Diode / 二极管
Maximum Rated Values / 最大额定值

Item	Symbol	Conditions	Values			Unit
			Min.	Typ.	Max.	
反向重复峰值电压 Repetitive reverse voltage	V_{RRM}	$T_{vj}=25^{\circ}C$		1700		V
连续正向直流电流 Continuous DC forward current	I_F	$T_C=25^{\circ}C$ $T_C=100^{\circ}C$		300		A
				170		
二极管正向不重复峰值电流 Diode pulsed current, tp limited by T_{Jmax}	I_{Fpulse}			600		A

Characteristic Values / 特征值

Item	Symbol	Conditions	Values			Unit	
			Min.	Typ.	Max.		
正向电压 Forward voltage	V_F	$I_F=300A, V_{GE}=0V$	$T_{vj}=25^{\circ}C$		2.45	2.80	V
			$T_{vj}=125^{\circ}C$		2.65		
			$T_{vj}=150^{\circ}C$		2.65		
反向恢复时间 Reverse recovery time	t_{rr}	$I_F=300A$ $di_F/dt=-4000A/\mu s$ ($T_{vj}=150^{\circ}C$)	$T_{vj}=25^{\circ}C$		160		ns
			$T_{vj}=125^{\circ}C$		230		
			$T_{vj}=150^{\circ}C$		270		
反向恢复峰值电流 Peak reverse recovery current	I_{RRM}	$V_R=900V,$ $V_{GE}=-15V$	$T_{vj}=25^{\circ}C$		380		A
			$T_{vj}=125^{\circ}C$		400		
			$T_{vj}=150^{\circ}C$		415		
反向恢复电荷 Reverse recovery charge	Q_{RR}		$T_{vj}=25^{\circ}C$		61		μC
			$T_{vj}=125^{\circ}C$		104		
			$T_{vj}=150^{\circ}C$		123		
反向恢复损耗（每脉冲） Reverse recovery energy loss per pulse	E_{rec}		$T_{vj}=25^{\circ}C$		29.7		mJ
			$T_{vj}=125^{\circ}C$		53.6		
			$T_{vj}=150^{\circ}C$		63.4		
二极管结-外壳热阻 Diode thermal resistance, junction-case	R_{thJC}				0.20	K/W	
工作温度 Operating Temperature	T_{Jop}		-40		175	$^{\circ}C$	

输出特性 (典型)

Output characteristic (typical)

$I_C = f(V_{CE})$

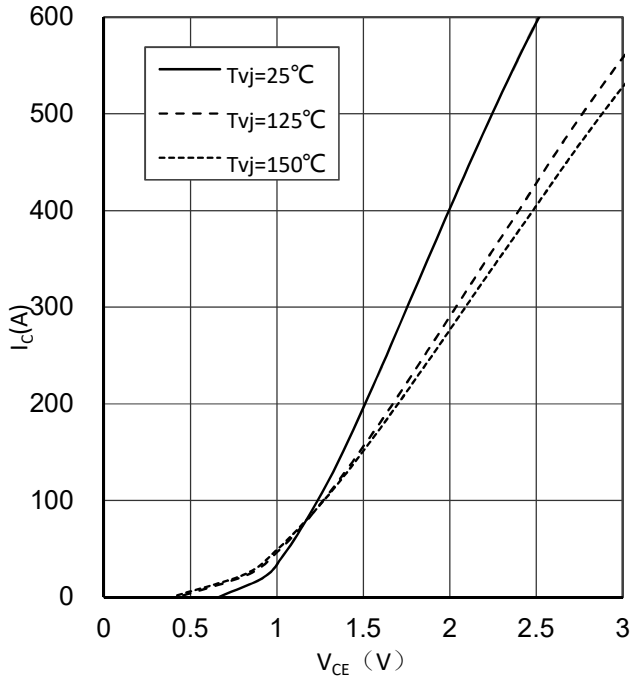

输出特性 (典型)

Output characteristic (typical)

$I_C = f(V_{CE})$

$T_{vj} = 150^\circ\text{C}$

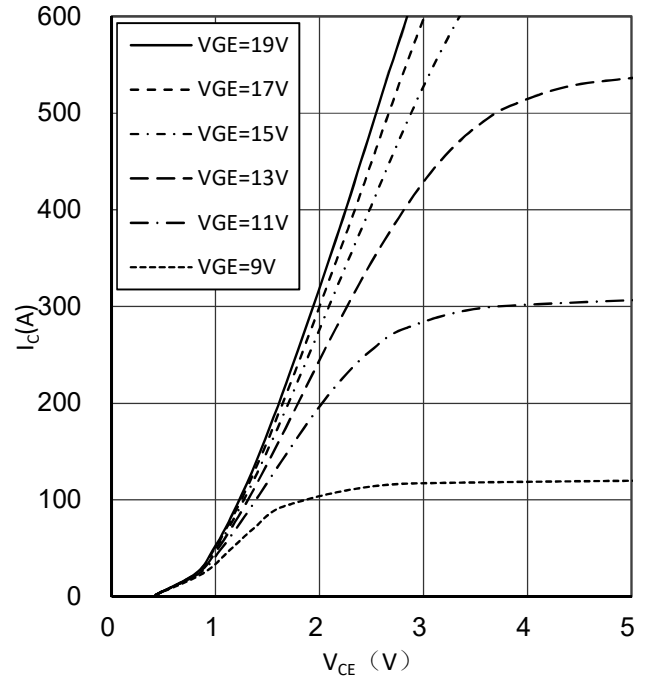

传输特性 (典型)

Transfer characteristic (typical)

$I_C = f(V_{GE})$

$V_{CE} = 20\text{V}$

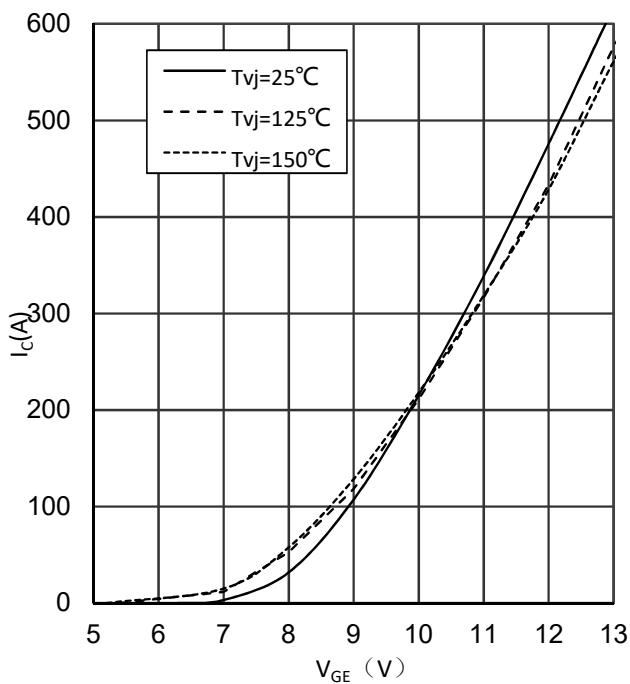

IGBT开关损耗 (典型)

Switching losses IGBT (typical)

$E = f(R_G)$

$V_{GE} = \pm 15\text{V}, I_C = 300\text{A}, V_{CE} = 900\text{V}$

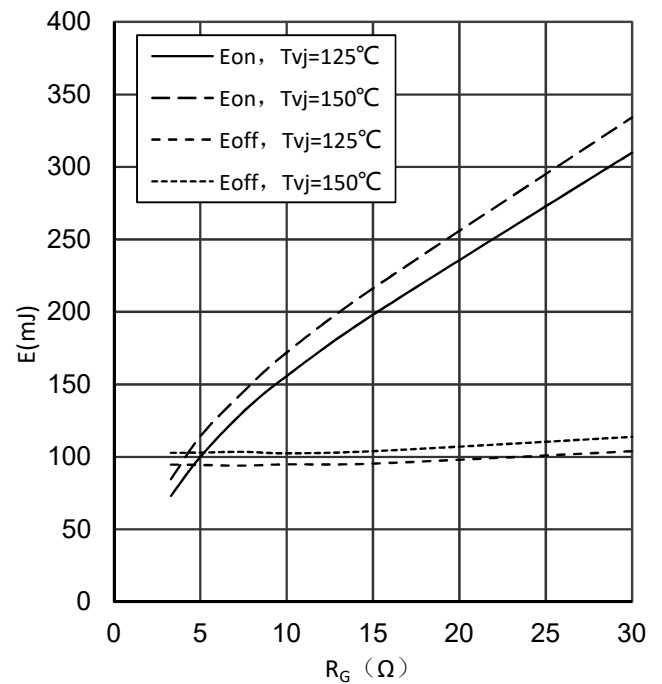

IGBT开关损耗 (典型)

Switching losses IGBT (typical)

$E = f(I_c)$

$V_{GE} = \pm 15V, R_G = 3.3\Omega, V_{CE} = 900V$

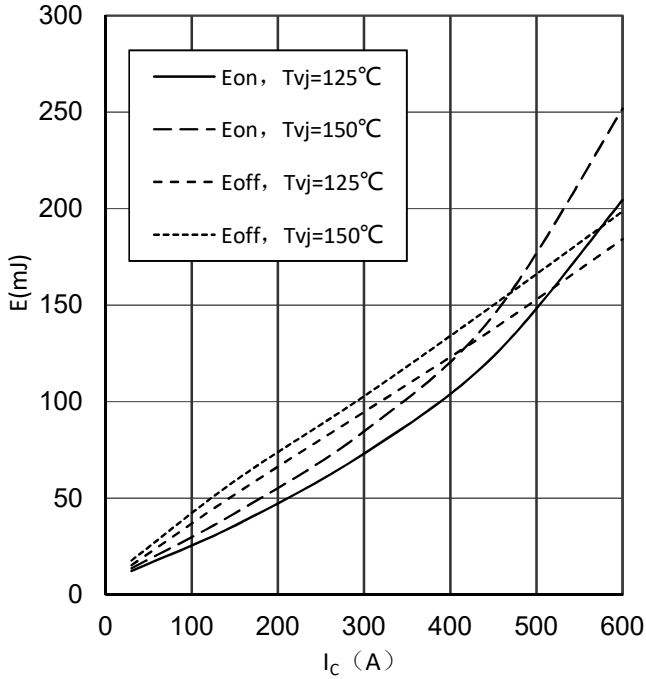

反偏安全工作区 (RBSOA)

Reverse bias safe operating area(RBSOA)

$I_c = f(V_{CE})$

$V_{GE} = \pm 15V, R_{Goff} = 3.3\Omega, T_{vj} = 150^\circ C$

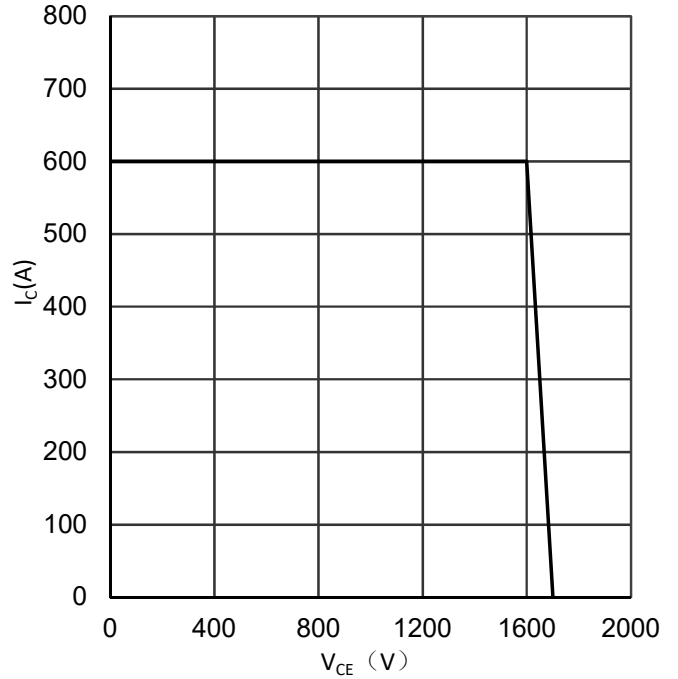

电容 (典型)

Typical capacitance as a function of collector-emitter voltage

$C = f(V_{CE})$

$f = 100\text{ kHz}, V_{GE} = 0V$

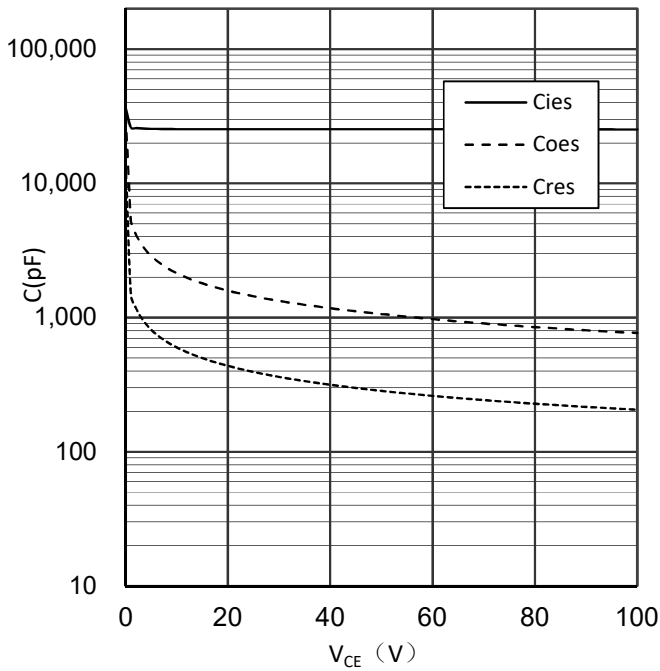

门极电荷 (典型)

Gate charge (typical)

$V_{GE} = f(Q_G)$

$I_c = 300A, V_{CE} = 900V$

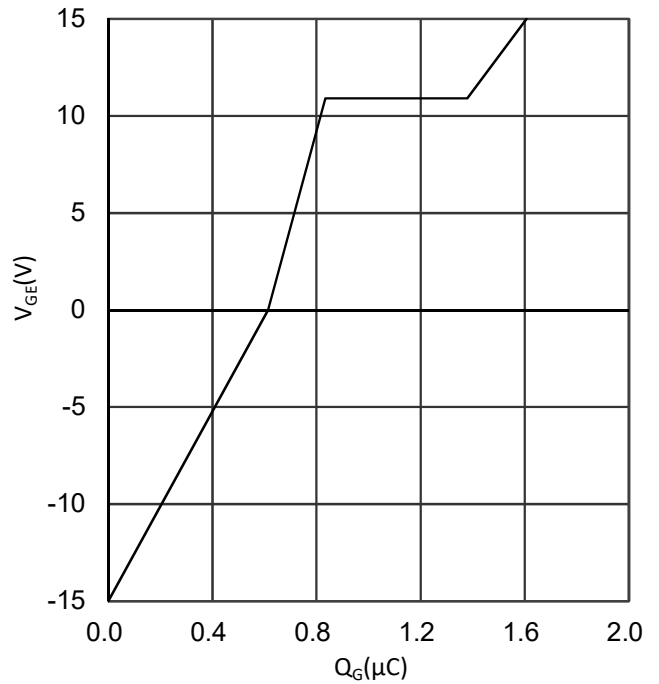

IGBT瞬态热阻抗

IGBT transient thermal impedance as a function of pulse width

$$Z_{th(j-c)} = f(t)$$

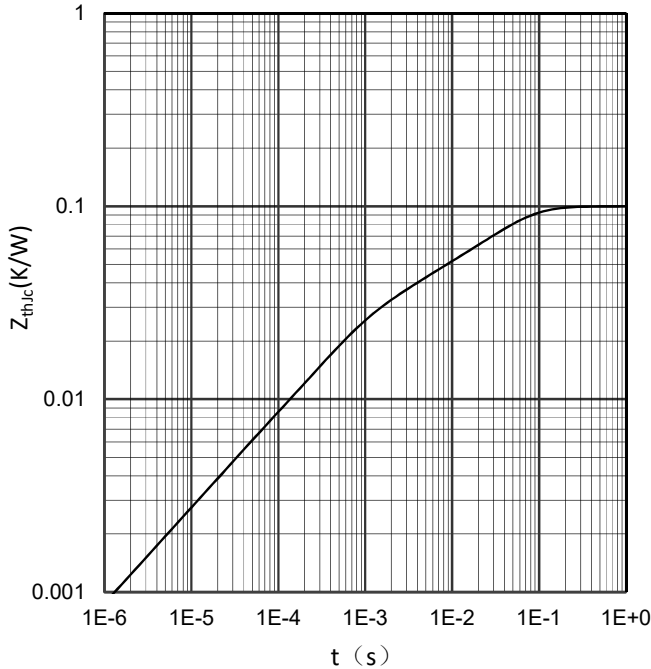

正向偏压特性 二极管 (典型)

Forward characteristic of Diode (typical)

$$I_F = f(V_F)$$

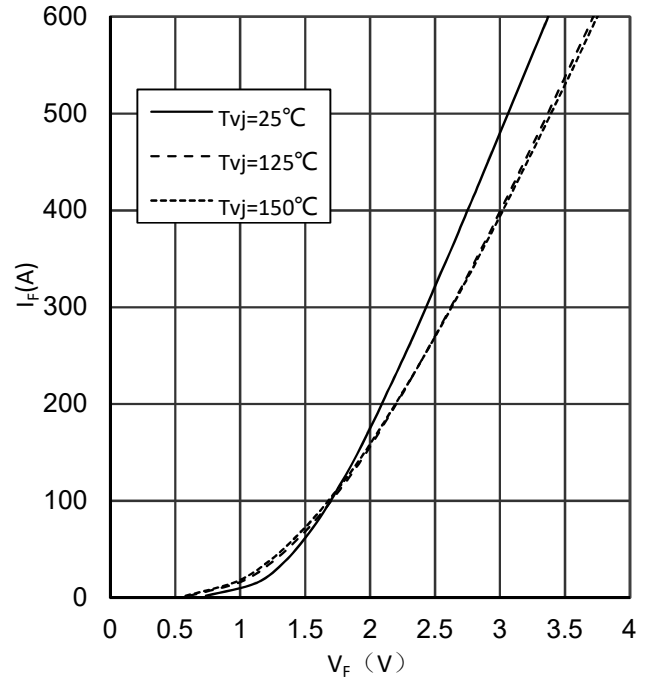

开关损耗 二极管 (典型)

Switching losses Diode (typical)

$$E_{rec} = f(R_G)$$

$I_F = 300A, V_{CE} = 900V$

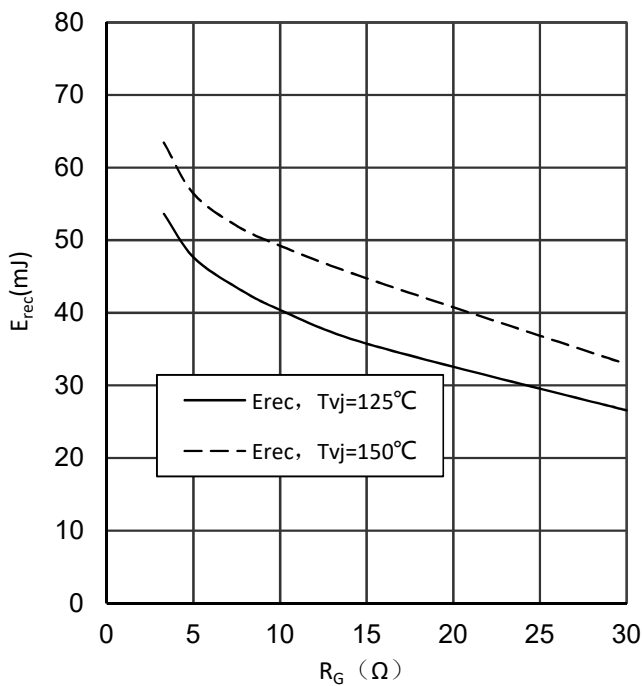

开关损耗 二极管 (典型)

Switching losses Diode (typical)

$$E_{rec} = f(I_F)$$

$R_G = 3.3Ω, V_{CE} = 900V$

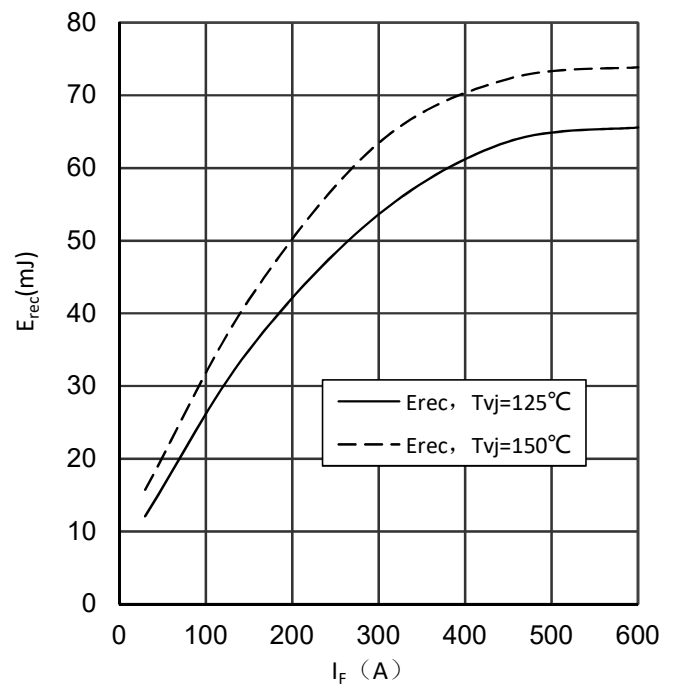

二极管瞬态热阻抗

Diode transient thermal impedance as a function of pulse width

$$Z_{th(j-c)} = f(t)$$

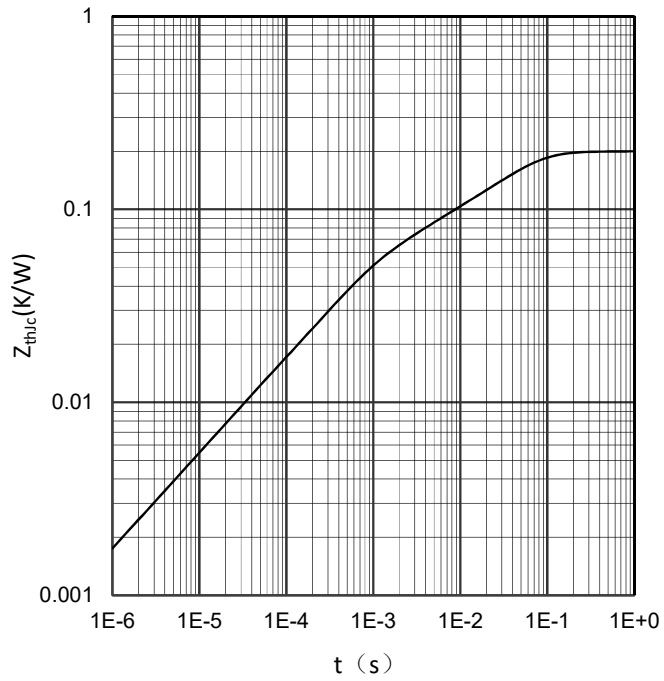

Circuit diagram headline / 接线图

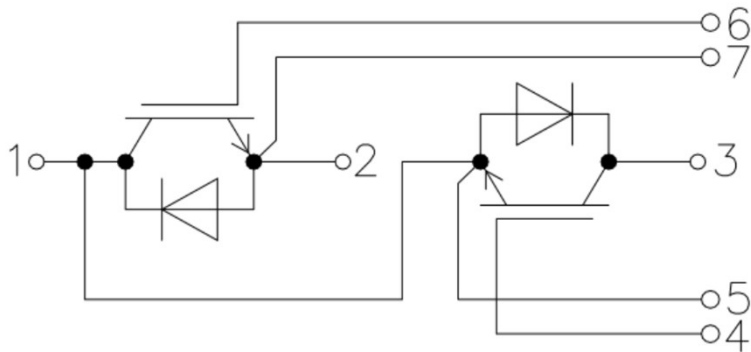

Package outlines / 封装尺寸

